

Residens Sannegården Göteborg  
 Torn 1  
 Plan 3  
 Balkong Lgh: 1103  
 Antal 1 st

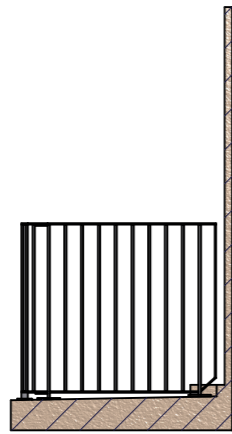

K-K ( 1 : 50 )

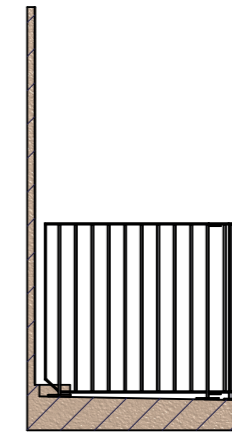
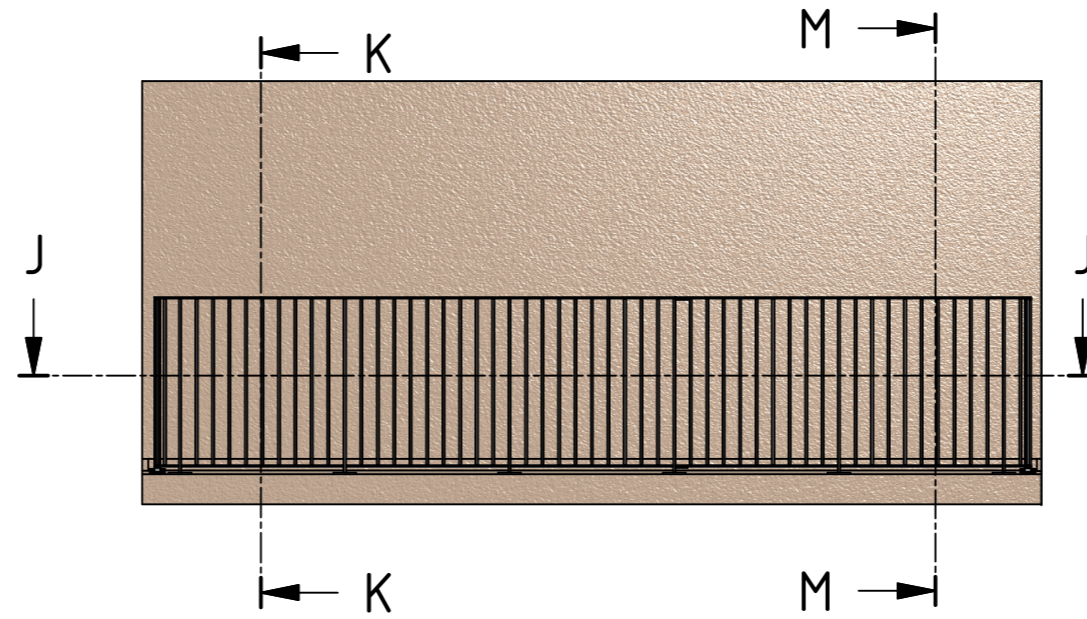

M-M ( 1 : 50 )

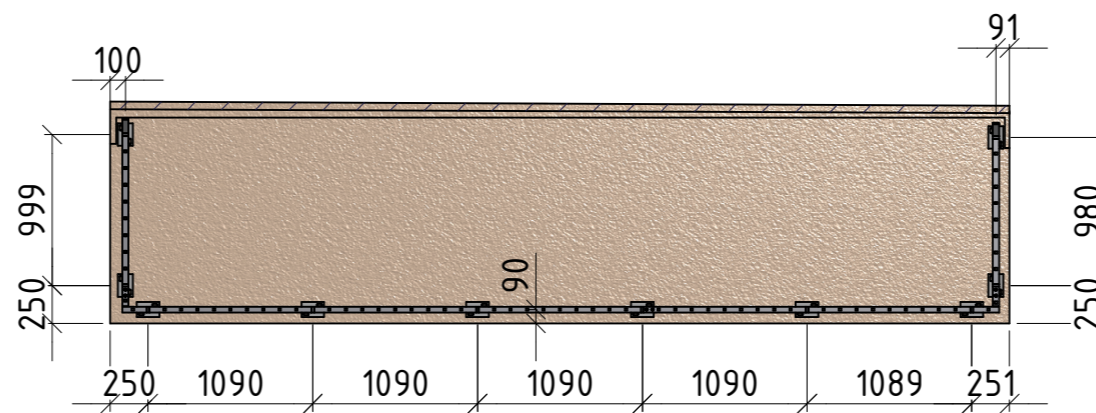
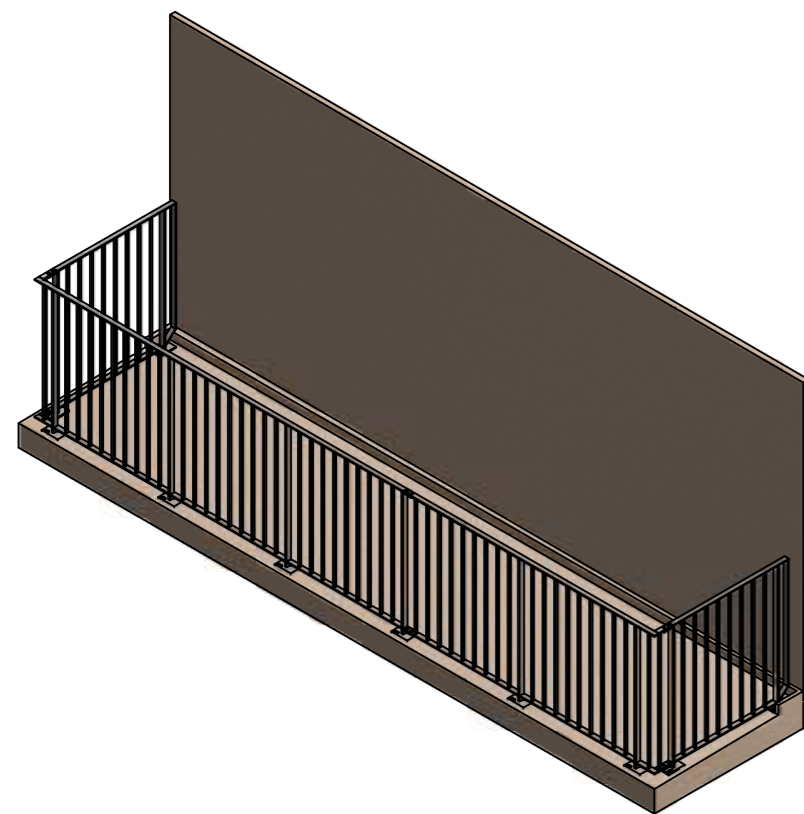
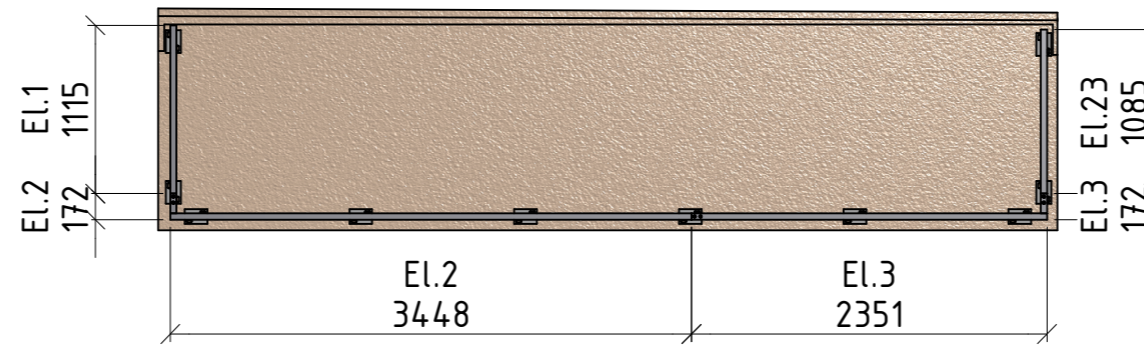

J-J ( 1 : 50 )

 Rewot AB tel 0589 198 65 Box 121 fax 0589 198 85 732 22 Arboga info@rewot.se www.rewot.se	STATUS Projektering		
	INTERNUMMER 384	PROJEKTNUMMER 384	DATUM 2013-02-11
	BESTÄLLARE Veidekke Entreprenad AB		
	PROJEKT Residens Sannegården Göteborg Räcke till lägenhet 1103		
PROJEKTERINGSANSVARIG	DESIGN C.E	LITT./DET.	
PROJEKTANSVARIG Christian Engberg	TELEFON 070-283 48 20	ORIG. FORMAT	SKALA
		RITINGSNUMMER T384-Lgh1103	REV.